

# Ripples

## Journal



*"Individually, we are one drop. Together, we are an ocean."  
Ryunosuke Satoro*

*A quarterly journal produced by the  
USACE National Water Safety Program  
with help from everyone within USACE  
that promotes water safety.*



**US Army Corps  
of Engineers** ®

**ISSUE 04  
FEBRUARY 2024**

---

## UTILIZE THIS JOURNAL TO...

---

- Showcase agency-wide what your division, district, or project is doing to promote water safety.
- Share your water safety initiatives to spark ideas in others.
- Show that you care about saving lives on our nation's waterways and that you have fun doing it.



---

### **Your Help Is Needed to Make This Journal As Good As It Can Be.**

- Send your water safety initiatives to your Division Representative on the National Water Safety Committee at any time and watch for emails from your division representative regarding their deadlines for submitting information.
- Include good quality pictures because a picture can be worth a thousand words.
- If it pertains to water safety send it in including but not limited to interpretive programs, special events, displays, promotional products, partnerships, visitor assistance items, etc.

---

### **Your Division Representatives on the National Water Safety Committee**

**LRD-Chelsea.J.Jones**

**NAD-Jenna.M.Conner**

**MVD-Erica L. Nabers**

**NWD/POD-Tana K. Wilson**

**SPD-Pamela.B.Bowie**

**SAD-Emily A. Jones**

**SWD-Abby L. Jones**

## Great Lakes and Ohio River Division Water Safety Initiatives

### Buffalo District (LRB)

Two Buffalo District park rangers Cole Schaefer & Thomas Wenzel were presented with the district's Clear Communication Badge for the public tours and information that they provide to thousands of visitors at the Mount Morris Dam and Recreation Area each year, which include water safety messaging and having a positive impact through communication.



The USACE Buffalo District re-marked the location of a submerged stone wall along the inside of Ashtabula Harbor's East Breakwater in Ashtabula, Ohio. The buoys location and purpose, along with additional safety information, has been shared via local marinas, boat ramps, and the U.S. Coast Guard through a Local Notice to Mariners (LNM).

### Chicago District (LRC)

J. Edward Roush Lake Manager Wesley Millar and Park Ranger Amber Arena promoted water safety at the Huntington Tails and Trails Festival. 84 direct water safety interpretive contacts were made.



Upper Wabash park manager and park rangers hosted local 7th graders for Career Exploration Day to share about their careers and the paths they took to do what they do.

### Detroit District (LRE)

Detroit District hosted SHPO Section 106 staff members for a multi-day tour of the historic shipping locks facilities and construction site for the new Soo Lock. All tours include water safety briefings and proper life jacket wear.





# Huntington District (LRH)

## Grayson Lake

Conducted their first ever Trunk or Treat event and it was a success! Approximately 1,600 people attended. Bobber the Water Safety Dog made appearances during the event and with the help of park rangers provided event attendees with water safety information and promotional items.



## Dewey Lake

Park Ranger Ryan Hicks provided water safety information and promotional items and Bobber the Water Safety Dog made appearances during the 1st Annual JISP Children's Health & Safety Fair at the Mountain Arts Center.



Park Ranger Ryan Hicks and Fishtrap Lake Park Ranger Mary Stiltner staffed a water safety table at the Jenny Wiley Festival.

## John W. Flannagan Lake

Park rangers gave shoppers at a local grocery store the reusable water safety bags that were provided by the National Water Safety Program and also provided them with some valuable water safety information that might save their life or the life of someone they care about. Bobber the Water Safety Dog helped the park rangers hand out the bags to the shoppers.



Park rangers from John W. Flannagan Lake along with many other agencies were invited to conduct educational sessions during an after-school program at Dickenson County Public Schools. Rangers Davis and Elliott conducted several different water safety programs for the students.

Participated in Christmas parades in the communities of Haysi, Clintwood, and Clinchco.



## Fishtrap Lake

Park Ranger Mary Stiltner was busy in the first quarter sharing water safety information at various holiday events, expos, and programs in the local community.





# Louisville District (LRL)

## Buckhorn Lake

Park rangers presented water safety interpretive programs to students from Carr Creek Elementary during the school's environmental fair.



Louisville District River Ranger Lisa Freeman and District Load Handling and Equipment Manager Wayne Wilkinson staffed an informational table at a “Who Works the River” event in Cincinnati. The Who Works the River events focus on high school students who may not have made career choices and offers them a chance to explore the options of all the different jobs available on the river. These events also provide opportunities to pass along some water safety information to the students. Something that Park Ranger Freeman mentioned to the students was this,

“The worst part of my job is looking for the body of a person that drowned, and the only thing worse, is waiting with the loved ones left behind while the search takes place, so please, wear your life jacket so I don’t have to do that for you.”

# Nashville District (LRN)

USACE employees representing different career fields including those from Cheatham, J. Percy Priest, and Old Hickory Lakes provided information to Antioch Middle School 6th, 7th & 8th graders during the Tennessee STEAM Festival event. Students learned about preserving natural resources, hydropower, navigation, biology, geology, recreation operations, emergency management, diving operations, drone uses, and water & boating safety, which are all associated with science, technology, engineering, arts, and mathematics.

## Lake Cumberland



Participated in the Pulaski County-Somerset Christmas Parade promoting water safety.

## Dale Hollow Lake

Park Ranger Desmaray Brown presented a water safety interpretive program to local kids.



## Lake Barkley



Park Ranger Mariah Rinehart staffed a water safety table at the Trigg County Ham Festival.

# Pittsburgh District (LRP)

Crooked Creek Lake  
Park Rangers Amberlee Bozic and Christian Clendenning presented water safety interpretive programs at Lenape Elementary's inaugural Back to School Carnival and staffed an area in the touch-a-truck portion of the event to provide participants with water safety promotional items. Bobber the Water Safety Dog made appearances during the event. Over 235 water safety interpretive contacts were made during the event.



Halloween decoration Bobber-style at the Crooked Creek Lake office.



The staff at Crooked Creek Lake printed off the Chilly Dog bookmarks that are available from the National Water Safety Program on the Bobber the Water Safety Dog website, [www.Bobber.info](http://www.Bobber.info), and made them available to everyone that stopped by the park office. They also had Bobber the Water Safety Dog coloring sheets and water safety items on their Christmas tree for visitors too. They also partnered with the Ford City Public Library and Kittanning Public Library to provide the Chilly Dog bookmarks at the libraries.



## Shenango River Lake



Participated in the Hermitage Light Parade to promote water safety.

Youghiogheny River Lake  
Youghiogheny River Lake staff participated in the 2023 Confluence Pumpkin Fest to promote water safety. Friends of the Youghiogheny River Lake supplied the candy and decorations that helped make the event a little brighter and sweeter for the members of the community. Bobber the Water Safety Dog made a special appearance during the event.



## Mississippi Valley Division Water Safety Initiatives

### New Orleans District (MVN)

#### Atchafalaya Basin Floodway System and Bonnet Carre Spillway Projects

On October 14, 2023, park rangers from Atchafalaya Basin Floodway System and Bonnet Carre Spillway Programs staffed an interactive area at the Wild Things Event that included water safety and project information. This annual event is hosted by the U.S. Fish and Wildlife Service at their headquarters office in Lacombe, LA. Over 1,200 interpretive contacts were made during the event. Louisiana state agencies and other federal agencies participated in this event too including NASA who distributed glasses to view the solar eclipse that will occur in April 2024.



#### Bonnet Carre Spillway

Four new Life Ring cabinets were ordered and installed at locations throughout the project. Life jacket loaner stations were cleaned and re-stocked with life jackets.

#### Atchafalaya Basin Floodway System

Boat patrols were conducted during duck season to provide visitor assistance and to enforce the life jacket wear requirement for all when operating tiller-steer outboard motors. In Louisiana, all persons on board a motorboat less than 16 feet which is being propelled by a hand tiller outboard motor are required to wear a U.S. Coast Guard-approved Type I, II, III or V PFD while the motorboat is underway.

Life jacket loaner stations were cleaned and stocked with life jackets.

The annual commercial crawfish permit for the Atchafalaya Basin Floodway System was updated with water safety messages. The project issues almost 200 special use permits annually and each permit holder is allowed up to 500 crawfish traps.

### Rock Island District (MVR)

#### Saylorville Lake

Park rangers from Saylorville Lake attended a joint training for side-scan sonar, held by the Iowa DNR at Big Creek State Park. Rangers learned how to use our Hummingbird Side-Scan Sonar efficiently and effectively for use in water emergencies. In attendance were other agencies that work around Saylorville Lake that assist in water emergencies.



Park rangers staffed a water safety information table at the Grow Wild Event at the Jester Park Nature Center. A water safety plinko game was provided so participants to the event could win a water safety prize for playing. This event was hosted by Polk County Conservation District and is a family-friendly event for all ages. More than 200 water safety interpretive contacts were made during the event.



On October 7, 2023, Saylorville Lake park rangers staffed a water safety interactive area at the Polk County Sheriff's Office Candy Crawl event. Many other agencies from around the area had safety-themed Halloween displays and demonstrations for all ages. Approximately 150 water safety interpretive contacts were made.



On November 19, 2023, park rangers staffed a water safety information table at the Iowa Wild Pucks-n-Paws hockey game. The information table was setup in the concourse area, which was a great location to talk to game attendees.

### Illinois Waterway Project

Park rangers from the Illinois Waterway Visitor Center continued their partnership with the St. Genevieve Paddlewheeler Riverboat in October. The park rangers narrated two tours a day on the river between Ottawa and Utica on October 10, 17, 19, and 24, 2023. These trips involved locking through at Starved Rock Lock and Dam and included important water safety information on how recreational boaters and paddlers should lock through safely.

On October 20, 2023, some students and staff from His Cross Lutheran School visited the Illinois Waterway Visitor Center. They were presented an interpretive program that included information about the Illinois Waterway and how a lock and dam functions and received water safety promotional materials. Since it was a 4th grade class they were also issued America the Beautiful passes.

On November 8, 2023, Park Ranger Sarah Fisher gave a talk about safety right of ways between recreation and commercial vessels on the river at the I & M Canal Corridor Conference held at the Four Rivers Environmental Education Center in Channahon, IL. The center is on the bank of the Des Plaines River just before the confluence with the Illinois River.

On November 21, 2023, Park Ranger Sarah Fisher gave a presentation at the I & M Canal Heritage Corridor Board Meeting. Park Ranger Fisher provided information about the Illinois Waterway Visitor Center, duties conducted on the Illinois River by USACE staff, and water safety. Board members were in attendance from communities as far away as Lemont and Joliet, IL.

### Mississippi River Project

On September 28, 2023, park rangers staffed two stations at the Tri-County Conservation Day held at Palisades Park in Savanna, IL. One of the stations was on Navigating the Mississippi River and the other stations was on water safety. At the water safety station students participate in a water safety relay race that included putting on life jackets and throwing a rescue device before racing back in line. 500 area students visit different education stations throughout the day during the event.



On October 18, 2023, Mississippi River Visitor Center volunteer Gene Sperry staffed a water safety table during the "Boo on the Rock" Trunk or Treat event held at the Rock Island Arsenal. Bobber the Water Safety Dog made an appearance during the event. This popular event is open to Arsenal families as well as members of the public and consists of both indoor and outdoor activities.

### Lake Red Rock

Purchased ad space to promote water safety in the Pella, IA Travel Guide and the Marion County, IA Travel Guide for the 2024 season.

Lake Red Rock continued its "Water Safety Wednesday" Facebook posts after the recreation season. Most of the social media content was provided via the Please Wear It Facebook page which provides many water safety posts pertinent to all seasons of the year. The Please Wear It Facebook and Instagram pages are managed by the National Water Safety Program in cooperation with The Corps Foundation.



To promote water safety during the holiday season the Lake Red Rock interpretive staff decorated a tree in their visitor center with water safety promotional products that visitors could take with them.

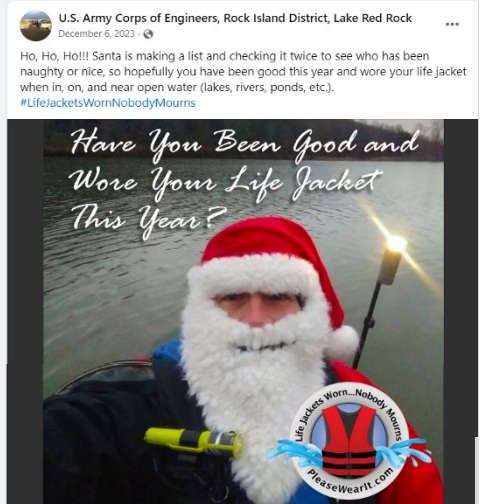

While many fair-weather boaters finish their season around Labor Day, there were still many fishermen that use Lake Red Rock during the fall months. To ensure off-season boaters still have access to life jackets, the life jacket loaner stations at the boat ramps remained stocked with life jackets until the courtesy docks were removed for the season. A volunteer that assisted with the loaner stations' weekly inventory and inspection during the summer continued to check them throughout the cooler months until her volunteer service ended for the year.



## St. Louis District (MVS)

### Carlyle Lake

Park rangers offered a Bobber the Water Safety Dog Scavenger Hunt as part of the annual Campers & Family Trick-or-Treat event in their Dam West Campground. An estimated 225 children and their families attended the event. Those that reported finding any of the 20 Bobber the Water Safety Dog images that were placed throughout the campground were awarded a water safety bag that included Bobber the Water Safety Dog water safety promotional products provided by the National Water Safety Program.



Posted water safety messages on Illinois Highway 27 digital reader board and on all of their day use information boards.



Promoted water safety while hunting in the 2023 Breese Journal Hunting Guide, which is distributed throughout the entire Clinton County, IL area.

The Carlyle Lake Haunted Trail event was held October 20 and 21, 2023 and the lake staff included haunting water safety displays along the trail. Over 1,600 people attended the event.

The five billboards, located in high visitation areas around Carlyle Lake were changed from summer to winter water safety messages.



## Mark Twain Lake

Conducted a walk through trick-or-treat event for all ages in their Indian Creek Campground that was closed for season. The water safety bags and promotional products were provided to all attendees. Four local partners will USACE conduct this event.

## Rend Lake

Park rangers partnered the Rend Lake Area Tourism Council to staff a booth at the annual Southern Illinois Hunting and Fishing Days. During the event the park rangers answered questions about USACE and activities at Rend Lake and shared water safety information and promotional products with attendees. 645 interpretive contacts were made during the event.



In October 2023, park rangers staffed water safety interactive areas at several community trick or treat events including the annual Trick or Treat the Campground at Wayne Fitzgerald State Park and a Trunk or Treat hosted by Rend Lake Marina. Bobber the Water Safety Dog made an appearance at both events, while park rangers shared water safety information and promotional items to attendees.

Park Ranger Breanna Whitley presented “Beavers: Nature’s Engineers” interpretive programs that focused on water safety at the Southern Illinois Conservation Fair. 196 water safety interpretive contacts were made during the event.



On October 31, 2023, the Rend Lake staff partnered with local businesses and organizations to host the annual Trick or Treat event at their Visitor Center. This event was open to the public, but specifically designed to meet the needs of pre-k and home school students. The event featured a water safety scavenger hunt, environmental education, and other activities related to USACE missions.



## Rivers Project

Lewis and Clark Community College hosted the National Great Rivers Research and Education Center 21st Annual Water Festival in Godfrey, IL. The event connects elementary school students to water, their local environment, and organizations that help conserve the environment. Nine regional schools were in attendance and rotated through various interactive areas including one staffed by Rivers Project park rangers where they conducted a water safety relay with the students. 250 water safety interpretive contacts were made during the event.



On October 18, 2023, in collaboration with River Works Discovery the National Great Rivers Museum hosted Who Works the River - a free career education event. At this event 200 students participated in a mini career fair and met with representatives from the maritime industry and related fields to become more informed about careers on America's rivers. Water safety practices were mentioned at many of the stations because they are an integral part of working at most of the companies that were at the event.

On October 31, 2023, Rivers Project park rangers participated in the 106th annual Alton Halloween Parade reaching thousands of parade spectators with water safety messages. Their parade float focused on today's pop-culture including Malibu Barbie promoting wearing a life jacket is the best accessory.



On November 3, 2023, a celebration event for the National Great Rivers Museum’s 20th anniversary was conducted. Twenty partnering organizations participated in the event. With help from St. Louis District Office staff and staff from other project offices a water safety interactive area was provided and Bobber the Water Safety Dog made special appearances during the event.



## Lake Shelbyville

To encourage water safety to visitors during the holiday season Lake Shelbyville Park Rangers decorated a Christmas Tree with Bobber the Water Safety Dog, Corkey, and Sinker ornaments in their visitor center. Copies of the ornaments were made available for visitors to take home. The ornaments were created by the National Water Safety Program and were available on [www.Bobber.info](http://www.Bobber.info) for a limited time in December.

Park Ranger Brock Key did a water safety interview with Shelbyville Radio Station, WTIM, that included the dangers of lake ice, the importance of wearing life jackets, and other water safety tips.



Several water safety ads were developed and provided to the Roxy Movie Theater in Shelbyville, IL to play before each movie starts. Every month highlights a different water safety tip.

Park Ranger Erica Nabers worked with Pam Doty, National Water Safety Program Manager and Toby Isbell, National Water Safety Program VI Specialist to have vinyl door wrap artwork created that included Bobber the Water Safety Dog and interactive activities. The door vinyl wraps have been ordered and will be placed on building doors at the beaches around Lake Shelbyville.



## Wappapello Lake



On October 14, 2023, Park Ranger Andrew Jefferson and volunteers staffed a water safety booth at Home Depot Safety Day. 226 direct water safety interpretive contacts were made during the event.

The Annual Greenville Jack-O-Lantern Jubilee was held at Greenville Campground in October 2023. Campers decorated their campsites and handed out candy to those that attended the event. Park rangers and volunteers staffed an informational booth that included water safety during the event.

The 31st Annual Wappapello Lake Festival of Lights Auto Tour was conducted from late November through December in Redman Creek Campground West that was closed for the season. Water safety messages were provided throughout the route of the auto tour. This event is done in partnership with the Wappapello Lake Area Association and River Radio.



## North Atlantic Division Water Safety Initiatives

The North Atlantic Division conducted a Make Me a Meme Contest and winners of round one were announced during their division conference in December 2023. Entries were judged by a panel of their colleagues based on originality, creativity, relevance, and humor.



## New England District (NAE)

### West Hill Dam

Posted this water safety message for hunters “Please wear your safety orange, protect your pets, and if you hunt from a boat, wear your life jacket!”

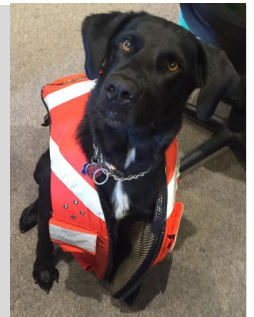

### Cape Cod Canal



Partners including USCG Auxiliary, Station Cape Cod Canal, and Flotilla 013-11-08 helped to promote boating safety through multiple collaborative public outreach events and vessel safety check opportunities along the canal. Additionally, the USCG Auxiliary secured, installed, and maintain a life jacket loaner station at the Sandwich Marina boat ramp, which is the only boat ramp at the east end of the Cape Cod Canal.

### Hopkinton Everett Lakes

Hosted the second annual Hopkinton Fall Festival at Elm Brook Park. Hundreds of visitors came to the park to enjoy cornhole games, live music, food trucks, and a fireworks display presented by the Contoocook Chamber of Commerce and Hopkinton Police Association. Hopkinton Everett Lakes staff utilized the New England District’s water safety trailer to teach event attendees how to choose the correct size life jacket, practice throwing a flotation device, and provided water safety promotional items to those that participated in the activities.

Ninety-five students from the Hopkinton 7th grade class visited the dam and Elm Brook Park during a two-day field trip in October 2023. Park Ranger Matt Hackett presented “Sink Fast” water safety interpretive programs at one of the field trip stations where the students participated in learning about water safety and how to choose and properly fit a life jacket.





## Hodges Village Dam



On October 14, 2023, a “Walktober” event was held at Hodges Village Dam, which consisted of a 2.2 mile float through a portion of the French River. The event included discussions highlighting water safety and the natural features of the river. All participants doing the float portion of the event had to wear a properly fitted life jacket.

## West Thompson Lake

Utilized funding from the Bipartisan Infrastructure Law (BIL) to make some much needed repairs to their boat ramp facility. These improvements included paving a portion of the parking area, improving drainage, and adding five parking spaces for boat trailers, thus improving visitor safety and accessibility to the lake for water-based recreation activities.



# Baltimore District (NAB)

## Jennings Randolph Lake



Park rangers assisted Bobber the Water Safety Dog in making appearances at the Annual Halloween Event at Jennings Randolph Lake, the Elk Garden Primary School Halloween Parade, and the community Halloween Parade in Elk Garden, WV. Park rangers and Bobber participated in Trunk-or-Treat at these events and walked along during the parades, helping to hand out water safety items.

Trunk-or-treat display created by Administrative Clerk Diana Foster to educate the public about paddle sports safety during events.



# Philadelphia District (NAP)

## Blue Marsh Lake

Bobber the Water Safety Dog and park rangers participated in the King Frost Halloween Parade in Hamburg, PA. Cold Water Safety was the topic of their float, reminding visitors to wear their life jacket. Along the parade park rangers handed out water safety promotional items.





This “Riddle Me This” was created by Jenna Conner, Raystown Lake Park Ranger and NAD Representative on the National Water Safety Committee.

# RIDDLE ME THIS

Answer my riddles five to better learn how to stay alive!!!

Around your middle, I should feel snug,  
On the water's surface, I'm your trusty hug.  
Orange or yellow, a buoyant embrace,  
You should always keep me on, just in case.

**What am I?**

In the air, a taste of flight,  
One swift jump from a great height.  
Rocks and currents, a hidden threat,  
A thrilling second you may regret.

**What am I?**

In waters deep, a mantra to heed,  
A way to help someone in dire need.  
Repeat these words, I do not doubt,  
They may just help a swimmer get out.

**What am I?**

Details of your voyage, drafted with care,  
Tell all your loved ones, I'm meant to share.  
Before you set sail, leave me behind,  
A lost seafarer, I may help them to find.

**What am I?**

Colorless, tasteless, a silent killer,  
Invisible enemy from a horror thriller.  
Headaches, dizziness, the symptoms are subtle,  
The cause of death may sometimes befuddle.

**What am I?**

Answers:  
Life Jacket  
Cliff Jumping  
Reach, Row, Throw, Don't Go  
Float Plan  
Carbon Monoxide

# Northwestern Division Water Safety Initiatives

## Kansas City District (NWK)

### Pomme de Terre Lake

A Light Up The Lake event was coordinated by the Pomme de Terre Lake Chamber of Commerce and was held at the USACE Damsite Park from December 1-31, 2023. Local businesses and non-profit organizations decorated campsites for the holiday season. The Pomme de Terre Lake staff designed and displayed a water safety message during the event that included wear your life jackets and enjoy the lake during the holiday season.

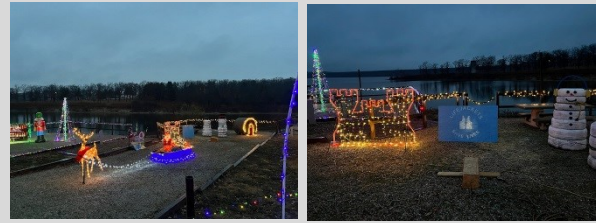

## Portland District (NWP)

### John Day Lock and Dam

To kick off the school year, park rangers and other staff visited a local elementary school to present an interpretive program on salmon, hydropower, and water safety. 75 direct water safety interpretive contacts made. Every student received some water safety promotional items as well as an Interagency 4th Grade Pass to promote the Every Kid Outdoors initiative.

In November 2023, Park Ranger Shannon Ritz presented at the Columbia Gorge Discovery Center during their Archeology Roadshow. Attendees of all ages learned about cultural history surrounding the Columbia River, created their own artwork, and participated in water safety activities. Approximately 100 interpretive contacts were made.

Park Ranger Alex Swicegood delivered over 400 water safety bags to community recreation centers, pools, libraries, schools, and daycares throughout Umatilla, Gilliam, and Morrow Counties. These materials will be used this upcoming spring and summer with their outdoor and reading programs that will focus on water safety on Lake Umatilla and Willow Creek Lake. There are plans for John Day Park Rangers to collaborate with local libraries this summer to support their programming initiatives (ie. "Reading with a Ranger") that will have a water safety message component and opportunities to receive water safety promotional materials.

### Willamette Valley Project

Several Natural Resource Management staff attended Oregon State University (OSU) and University of Oregon's (UO) career fairs. They were there to recruit students for several positions open in the NRM program at the Willamette Valley Project and share USACE missions. At OSU, 95 direct interpretive contacts were made and students were given a water safety sticker with a beaver on it when they visited the booth. At UO, 65 direct interpretive contacts were made and these contacts were given a water safety sticker with a duck on it. Both University students and staff were very excited to put their new water safety stickers on their water bottles and laptops to show off around campus.



A new event attended this fall was STEM Day in Salem, OR hosted by Girl Scouts of Oregon and Southwest Washington. Park Rangers Paige King and Becca Jones partnered with Salina Hart, Chief of Reservoir Regulation & Water Quality Section to staff a booth at the event. Approximately 380 direct interpretive contacts during the event. The booth display focused on the benefits of dams in the Willamette Valley Project, how hydropower is made, careers in STEM, and water safety. Girl Scouts got to practice putting on life jackets, using a throw rope, and were given water safety materials to take home.



Dam tours picked back up at Lookout Point and Foster Dams. Park rangers stressed water safety awareness during the tours. Tours were provided to local homeschooled groups and watershed classes.

### The Dalles Lock and Dam



Columbia River Inter-Tribal Fish Commission hosted their annual Trunk or Treat event in The Dalles Lock & Dam Visitor Center parking lot. Park rangers decorated the interior of the Visitor Center for the event and Bobber the Water Safety Dog made a surprise appearance and with assistance from park rangers provided water safety messaging and promotional materials to event attendees.

## Seattle District (NWS)

### Libby Dam

On October 31, 2023, staff decorated their patrol truck with mannequins, life jackets and other props to help teach local families about water safety at the community Trunk or Treat event. Bobber the Water Safety Dog with assistance from Park Ranger Susan James made an appearance during the event. Water safety tips and information about the loaner life jacket program were shared with event attendees. This is the first year Libby Dam staff participated in this event. Approximately 600 direct water safety interpretive contacts were made.



## Walla Walla District (NWW)



On October 7, 2023, Walla Walla District NRM Team staffed an interactive area at RiverFest 2023 at Columbia Park in Kennewick, WA. Information and activities regarding the workings of turbines, improvements of fish survival, and the importance of water safety were provided to event attendees.

### Mill Creek

In December 2023, staff and Bobber The Water Safety Dog participated in annual holiday parade in Walla Walla, WA.

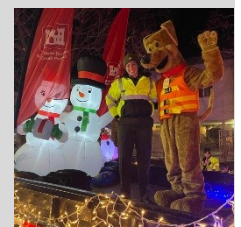



# South Atlantic Division Water Safety Initiatives

## Jacksonville District (SAJ)

### Okeechobee Waterway

On October 21, 2023, Park Ranger James Norris of the Southern Florida Operations, Saint Lucie Office conducted an interpretive program at FireFest held at Jonathan Dickinson State Park in Hobe Sound, FL. Park Ranger Norris provided information on USACE, park ranger duties at the Okeechobee Waterway, and water safety during the program. Water safety topics that were covered during the program included proper fitting and wear of life jackets, rescue procedure using reach, throw, row, and don't go techniques, and safe boating on the Okeechobee Waterway.



On November 2nd and 3rd, 2023, the Southern Florida Operations, Okeechobee Waterway Park Rangers presented water safety interpretive programs to 250 students during a safety day event. Groups of students were rotated to different stations at the event every 15 minutes. Water safety topics covered by the park rangers during the event included proper fitting and wear of life jackets, throwing a ring buoy, and tips for safe swimming.

On December 6, 2023, Saint Lucie Park Rangers and Bobber the Water Safety Dog met with Sergeant Taylor from the U.S. Marine Corps Florida Reserves for a photo opportunity to promote Toys for Tots and USACE.



## Mobile District (SAM)

### Alabama River Lakes

October 6 - 15, 2023, park rangers staffed a booth at the Alabama National Fair in Montgomery, AL to promote water safety and the project's parks. 4,100 interpretive contacts were made during the event.



October 30 - November 4, 2023, park rangers staffed a booth at Selma Fair in Selma, AL to promote water safety and the project's parks. 600 direct water safety interpretive contacts were made during the event.



## West Point Lake

On October 5, 2023, West Point Lake held its 44th annual “Special Day for Special People” event at Rocky Point Recreation Area. This event gave the mentally and physically challenged individuals in the local community a chance to experience outdoor recreation. Activities during the event included boat rides (everyone that went on a boat ride had to wear a life jacket), a photo booth, bouncy castles, music, and food. Bobber the Water Safety Dog made a special appearance to interact with the participants. Over 800 participants showed up for the event, making it one of West Point Lake’s largest events of the year.



On October 27, 2023, West Point Project staff participated in a Trunk or Treat event at Fairfax Elementary School in Valley, AL. Park rangers and other staff gave out water safety promotional items to over 660 kids. Bobber the Water Safety Dog was also present to help spread the message of water safety by interacting with the kids.

West Point Park Rangers and Bobber the Water Safety Dog participated in two Christmas parades to promote water safety. On November 30, 2023, Park Rangers Mike Linville and Kevin Parsons, along with Bobber and some helpful volunteers participated in the annual Christmas Parade in LaGrange, GA. On December 7, 2023, Park Rangers Christine Dowell and Derrick Wilkerson, along with Bobber the Water Safety Dog participated in the annual Greater Valley Area Christmas Parade, which starts in West Point, GA and ends in Valley, AL.



## Walter F. George Lake



Every year during the months of October and November, Walter F. George Lake partners with the Eufaula Recreation Center in Eufaula, AL to present water safety interpretive programs during swimming lessons to 2nd graders. There were a total of three days that Park Ranger Shannon Schaefer presented water safety programs in conjunction with the swimming lessons. There were three classes each day, typically 20 children per class, that attended the program to learn about the importance of life jackets and proper rescuing techniques.

November 3 - 11, 2023, park rangers and volunteers staffed a booth at the annual National Peanut Festival in Dothan, AL. There were 3,141 interpretive contacts made during the event. During the event they gave away twenty-five donated life jackets to kids in need of a life jacket to use for swimming and boating.



Park rangers, volunteers, other staff, and Buddy Beaver participated in two Christmas parades in 2023 in Abbeville, AL and Blakely, GA. Other parades they participated in during 2023 were in Eufaula, AL and Fort Gaines, GA. The annual Christmas tree at the lake resources management office was decorated by park rangers and volunteers with water safety promotional items, so visitors to the office could take an item from the tree to take home with them.

# Savannah District (SAS)

## Hartwell Lake

Park rangers presented career day and water safety interpretive programs at North Hart and South Hart Elementary Schools in Hartwell, GA reaching over 400 students. In November 2023, thirty-five McCormick County High School students came to Hartwell Lake to learn about water safety, project history, and USACE careers.





# Wilmington District (SAW)

## John H. Kerr Lake

On November 2, 2023, Park Rangers Will Daniel and Emily Jones staffed a table at the Night in the Park Launch into Learning event hosted by Victoria and Kenbridge Elementary Schools located in Victoria, VA. Park Rangers Daniel and Jones spoke to approximately 75 event participants about native nocturnal animals and handed out water safety promotional items.



On November 27, 2023, Park Rangers Emily Jones and Richard Brown staffed a table at the Warren County Middle School Career Fair where they interacted with hundreds of students. The park rangers discussed careers, job duties, opportunities for employment within USACE and water safety with the students.



Over the first two weekends in December 2023, the staff from John H. Kerr Lake participated in four area Christmas Parades that were held in Clarksville, South Hill, and Boydton, VA and Henderson, NC to promote water safety and show community involvement.

## Philpott Lake

October 17, 19, 24, and 26, 2023, park rangers conducted a black willow planting days with local 4th graders. On planting day, the students rotated through environmental stations and a water safety station. At the water safety station they were shown how to wear a life jacket and proper rescuing techniques. Over 500 direct interpretive contacts were made during the event.

On October 8, 2023, partners from Dan River Basin Association, partnering organization with Philpott Lake, took a boat tour with Park Ranger Dillon Brown. During the tour Park Ranger Brown discussed swim beach safety, access points, and potential natural resource projects with the partners.

On December 1 and 2, 2023, park rangers and Bobber the Water Safety Dog participated in two local Christmas parades to promote water safety. They decorated their patrol boat with life jackets and wore their own life jackets and passed out water safety promotional items during the parades.

SPD

## South Pacific Division Water Safety Initiatives

October 25 - 27, 2023, SPD Park Rangers attended the Western Dredging Association Meeting in order to share water safety expertise with the attendees. Topics included current public recreation fatality statistics, the importance of wearing a life jacket when in, on, or near open water, boater hypnosis, carbon monoxide poisoning while boating, and hypothermia. Park rangers staffed a water safety booth, presented a water safety interpretive program, and provided information about safety gear to meeting attendees that participated in the California Princess Flagship Cruise.





# Albuquerque District (SPA)

## Abiquiu Lake

On October 28, 2023, Park Rangers Kara Rapp and Pam Bowie promoted water safety during the 3rd annual Trunk Or Treat event at Abiquiu Lake. Seamoor Safety the water safety sea serpent made appearances during the event.



On December 9, 2023, Abiquiu Lake staff John Burman, Kara Rapp and Justin Maestas and volunteers participated in the annual Espanola, NM light parade to promote water safety. The patrol boat was decorated by Abiquiu Park Rangers and Abiquiu Lake Amigos, which is Abiquiu Lake's Friends group.

## John Martin Dam

On December 16, 2023, park rangers and Bobber the Water Safety Dog participated in the Las Animas Light Parade.



# Sacramento District (SPK)

## Pine Flat Lake

Park Rangers Julian Mendez, Evelyn Mejia, and Jack Kinney frequently utilize the district water safety trailer for events like Fresno Kids Day, Sanger National Night Out, Brighten Academy Community Helper Day, and Hero Night Farmers Market. Park Rangers utilize displays, interactive activities and games, and promotional materials to promote water safety to all ages. Approximately 1,226 direct water safety interpretive contacts were made during the events.



# San Francisco District (SPN)

## Lake Mendocino

On October 14 - 15, 2023, Park Rangers Kevin Haney and Sadie Parker staffed an interactive area at the City of Ukiah's Pumpkinfest community event to promote water safety. They provided information on the "seven deadly swims" that is mentioned on the poster provided by the National Water Safety Program and how to avoid them. Event participants could spin the water safety wheel to win water safety promotional items. Over 1,000 direct water safety interpretive contacts were made during the event.



## Lake Sonoma

Bobber the Water Safety Dog showing off the life jacket loaner station in the Lake Sonoma visitor center.



# Southwestern Division Water Safety Initiatives

## Fort Worth District (SWF)

### Whitney Lake

On October 4, 2023, Park Rangers Jarod Briscoe and Kathryn Devers staffed an interactive area at the City of West's National Night Out event that showcased first responders within the community. Park rangers educated the public about the importance of wearing life jackets and provided other water safety tips. Event participants were able to test their skills at throwing a rescue throw bag. The patrol boat was one of the highlights of the event for a lot of kids as they got to observe different water rescue techniques.



### Lake O' the Pines

On October 4, 2023, Park Ranger Caleb Bates and Maintenance Worker Nathan Collums staffed a water safety table at the National Night Out event in Jefferson, TX.



On December 8 and 9, 2023, Lake O' the Pines staff hosted their fourth annual "A Brushy Creek Christmas" event, which is a free drive thru holiday light show for the public. Volunteers and the Friends of Lake O' the Pines group helped with this event. In exchange for free camping, campers had to decorate their sites with holiday lights to create the drive thru light show. There were two categories that the campers could compete for prizes: best overall decorated site and best water safety site. Almost 50 campers decorated their campsites for the event.

### Wright Patman Lake

Throughout the month of October 2023, Park Rangers and Bobber the Water Safety Dog have continued visiting with Atlanta Primary Students during their STEAM events to discuss water safety with them.



On October 21, 2023, Park Rangers Lynlee Russell, Logan Lovelace, and Dustin Flowers staffed a water safety interactive area at Texas State Parks Centennial Event held at Atlanta State Park. Kids during the event were able to try on different types of life jackets and learn how to wear them properly. Bobber the Water Safety Dog made appearances and over 150 direct water safety interpretive contacts were made during the event.

On October 19, 2023, Park Rangers Logan Lovelace and Lynlee Russell staffed a water safety information table at the TxDOT employees 11th Annual Safety and Wellness Day event in Atlanta, TX. Over 300 direct water safety interpretive contacts were made.



On October 13, 2023, Park Ranger Lynlee Russell and volunteers David Barton, Mary Wiswall, and Jeff Wiswall presented a Friday the 13th cartoon night in Malden Lake Park. Campers enjoyed watch Bobber the Water Safety Dog and Casper the Ghost cartoons. Thirty-two direct water safety contacts were made.



On October 13, 2023, Park Ranger Lynlee Russell presented a water safety interpretive program to the Maud Community Helpers in the Malden Lake Campgrounds. The students learned about the importance of wearing a properly fitted life jacket as well as the role of USACE park rangers.



On November 16, 2023, Park Ranger Dalton Howell staffed a water safety booth at the Texarkana College Fall Fest. He spoke with students about water safety and USACE career opportunities.



On December 3, 2023, Park Ranger Lynlee Russell, Volunteers Steve and Diana Cash, and Bobber the Water Safety Dog participated in the Atlanta, TX Christmas Parade.

On December 4, 2023, Park Rangers Lynlee Russell, Logan Lovelace, and Dustin Flowers and Bobber the Water Safety Dog participated in the Texarkana Christmas Parade.

On December 8 and 9, 2023, Wright Patman Lake hosted its 2nd Annual “A Rocky Point” Christmas event. Several campers participated in the water safety and holiday decorating contest.



### Lake Georgetown



Park rangers conducted 177 hours of routine boat patrol and made over 27,000 direct water safety contacts during the 2023 summer recreation season.

Park Ranger Tanner Creel, volunteer park hosts, and Bobber the Water Safety Dog participated in the 2023 Leander Community Christmas Parade. They decorated their patrol boat with holiday decorations and water safety messages.



Staffed a table at a water safety and career fair at Georgetown High School in Georgetown, TX. Over 1,000 direct water safety interpretive contacts were made during the event.

### Trinity Region



During the Texas State Fair opening weekend, park rangers from the Trinity Region staffed a booth in a shared space with the Texas Parks and Wildlife Department. They interacted with the public providing them with information regarding USACE missions and water safety. Approximately 1,500 direct water safety interpretive contacts were made during the event.

### Waco Lake

On October 19, 2023, Park Ranger Matthew Dutton staffed an information table at TxDOT’s Waco District Employee Wellness Fair to promote water safety and share information about recreational opportunities at Waco Lake. 250 direct interpretive contacts were made during the event.

On December 1, 2023, Park Ranger Matthew Hackler staffed a booth at the Waco Cardiology Employee Health and Wellness Fair to provide information about the USACE missions and water safety. 136 direct interpretive contacts were made during the event.

### Ray Roberts Lake

On October 28, 2023, Lewisville Lake Park Ranger Jennifer Lawson and Waco Lake Park Ranger Cara Niemietz staffed a water safety table at the Trunk or Treat event hosted by Texas Park and Wildlife in Johnson Branch Park at Ray Roberts Lake.





### Sam Rayburn Lake

On October 31, 2023, Park Ranger Emily Laperriere and volunteers staffed a water safety table at the Scarecrow Festival Trunk or Treat event. Kids were provided water safety promotional items and could practice throwing a rescue throw bag.



On October 28, 2023, Park Rangers Reed Elmore, Cass Garrigus, and Gina Jaworski from Sam Rayburn Lake and Town Bluff Lake staffed a booth at the Super Spooky Safety Saturday event at the Woodland Heights Medical Center in Lufkin, TX to promote water safety. Bobber the Water Safety Dog made appearances during the event.

### Proctor Lake

On November 30, 2023, Park Rangers Elyssa Mendez and Jared Harris, CET Carl Beamer, Admin Becky Bostick, and many volunteers participated in the annual Brownwood Lighted Christmas Parade. The staff decorated their patrol boat and passed out water safety promotional items during the parade.



On November 15, 2023, Park Rangers Elyssa Mendez and Jared Harris staffed a table at Stephenville ISD's career day at Chamberlain Elementary. The park rangers spoke to the first and second graders about the roles of park rangers and water safety. The students were shown how to properly wear a life jacket and received water safety promotional items.

On December 9, 2023, Park Ranger Jared Harris, CET Carl Beamer, Admin Becky Bostick, volunteer Gayle Craig, and Bobber the Water Safety Dog participated in the annual Comanche, TX Christmas Parade. Proctor Lake staff decorated their patrol boat with holiday lights and water safety messages to be in the parade.

### Hords Creek Lake

On December 2, 2023, Park Rangers Ron Morris and Zane Allen staffed a booth at the Coleman Christmas Festival to promote water safety.

### Stillhouse Hollow Lake

On Friday, December 10, 2023, Boy Scout Elliott Lehman and friends constructed and installed 2 life jacket loaner stations to complete his Eagle Scout Project. The life jacket loaner stations are located at Union Grove Park boat ramp and swim beach area. All project materials except the sign were donated to the Stillhouse Hollow Lake through this Eagle Scout Project.



## Little Rock District (SWL)

### Table Rock Lake

On November 11, 2023, Park Rangers Bradley Mitchell, Zach Morris, Coleson Cowart, Grant Mustoe, and Bobber the Water Safety Dog participated in the Branson, MO Veterans Day Parade to show support to veterans and promote water safety.



Staff demonstrated their new rescue throw bag cornhole game at the PROSPECT Interpretative Services course held at the Dewey Short Visitor Center. The goal of utilizing the game during the course was to show students how to incorporate water safety into outreach events and interpretive programs. Twenty-seven park rangers from across USACE attend the course and while wearing life jackets had fun playing and learning about the new water safety game.

Here are the specifications for Table Rock Lake's Rescue Throw Bag Cornhole Game that was mentioned and shown on the previous page. If you would like to build this game and need more information about it contact Park Ranger Ryan Braaten at [Ryan.C.Braaten@usace.army.mil](mailto:Ryan.C.Braaten@usace.army.mil) or 501-340-1933.

Comments from Park Ranger Braaten regarding the game. The first rule of interpretation is steal and make it your own. After all, why reinvent the wheel if you don't have to. That's exactly what I did when I saw the Pittsburgh District's Facebook post using this cornhole style game to promote water safety during their Lock Fest event. The game gave visitors the opportunity to practice throwing a rescue throw bag. I immediately reached out to Nichol Govan in the Pittsburgh District who got me in contact with James Burford who built it. James walked me through what he did and gave me some rough estimates on sizes. He didn't have a drawing because he built theirs out of scrap wood, so I put together the specs shown below. The game is very big, 4 foot by 6 foot, and heavy. The hole is 20 inches in diameter so it's not too difficult to get the throw bag in it. Remember, the goal is to teach people how to get a throw bag and its rope near someone in the water. To help transport the game, I attached two removable 12" lawn mower wheels to the sides and handles on the top outer edge. Because of its size and weight, plan on having two people move it. I built two of these and plan on using them at outreach events and water safety interpretive programs. Let the games begin!

## Throw Bag Cornhole

### Materials Needed:

- 1 - 3/4" plywood (cut 4'x6')
- 2 - 2" x 4" x 6'
- 4 - 2" x 4" x 45"
- 2 - 2" x 4" x 16" legs rounded and collapsible
- 2 - metal handles for both short sides centered for carrying
- 2 - 2 1/2" wood screws and washers for legs

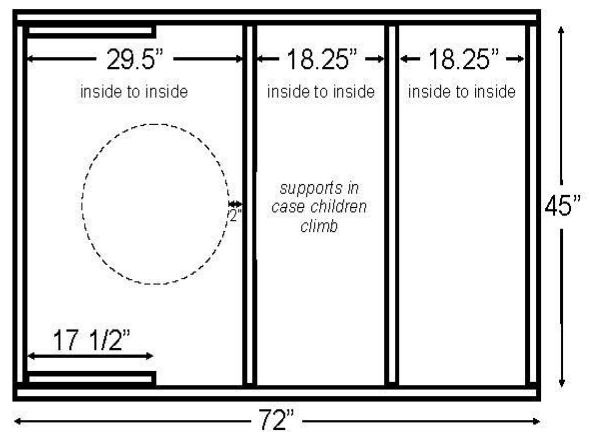
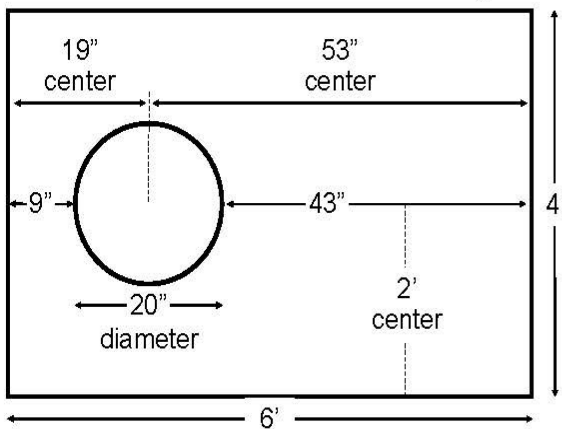

Legs: Wood screws + washers into side 72" 2x4s. Mounted to corners of frame so legs rest at 90° on frame when extended.

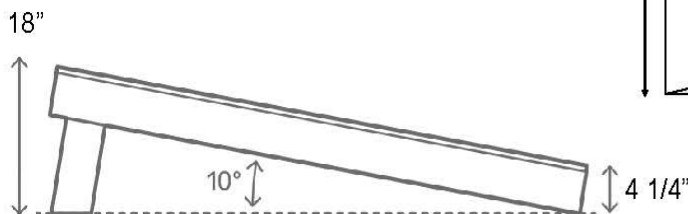
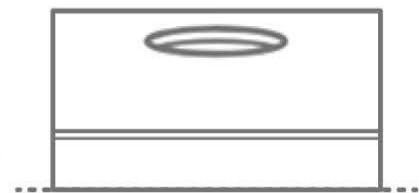
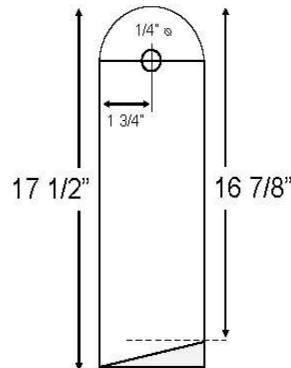

### Greers Ferry Lake

On October 19, 2023, Park Rangers Mary Nash and Sarah Wyatt were part of a set of programs called the Circle of Love at Heber Springs Head Start. Topics discussed with the 30 pre-k students included water safety, wildlife, and what a park ranger does.



On November 7, 2023, park rangers hosted a Heber Springs, AR 9th grade field trip. 125 students rotated through different stations that included water safety, environmental stewardship, tour of the visitor center, Greers Ferry Dam construction video, and powerhouse tour.

### Clearwater Lake

Park Ranger Don Henson and Volunteer Gale Wells participated in the Piedmont Christmas parade to promote water safety.

### Pine Bluff Lake

Park Rangers Aaron Boswell and Colby Bagwell staffed an information table, which included water safety, at the Wetlands and Wildlife Festival that was conducted at the Gov. Mike Huckabee Delta Rivers Nature Center.

## Tulsa District (SWT)

Tulsa District and Kansas City District worked together to staff an interactive area at the Kansas State Fair in Hutchinson, KS. Staff from Operations, Regulatory, and Safety Offices helped work the interactive area. Bobber The Water Safety Dog made special appearances. Water safety was promoted through the use of a water safety quiz that visitors could access on their cellphones by scanning a QR code and upon completion of the quiz they received a water safety promotional item. 10,633 direct interpretive contacts were made during the event.



Tulsa District Navigation and Operations staff partnered with River Works Discovery to support the annual "Who Works the River?" event hosted by the Tulsa Port of Catoosa. USACE staff educated high school juniors and seniors about the USACE missions, water safety, and career opportunities.

On November 11, 2023, the Tulsa District participated in the annual Tulsa, OK Veterans Day Parade to honor veterans and promote water safety. Members from Executive Office, Bobber the Water Safety Dog, and staff from Operations, Engineering, and Resource Management Divisions participated in the parade.



### Kaw Lake



Park rangers staffed a water safety interactive area at the "Goblins on Grand" event in Ponca City, OK. The interactive area included a water safety ring toss and water safety tips were shared with event participants. Bobber the Water Safety Dog made appearances during the event.

### Big Hill Lake

Staff participated in the 2023 Neewollah Grand Parade in Independence, KS to promote water safety. Their patrol boat was decorated with water safety banners.





## Eufaula Lake

Natural Resource Specialists Justin Briley and Joshua Springer staffed a water safety interactive area at a trunk or treat event hosted by a local church near Eufaula Lake.



## Keystone Lake



On October 27, 2023, park rangers presented “Keystone Camp-O-Ween” event at Brush Creek Recreation Area. The event included water safety games and promotional items as prizes. Bobber the Water Safety Dog made appearances during the event.

USACE

# National Water Safety Program Resources and Initiatives

## Required Water Safety Training for Employees and Volunteers

One change in the new Safety Manual, effective date of 15 March 2024, is that the following has been added to Chapter 1.

### Chapter 1-3. Personnel Required Qualification/Training.

(7) Employees and volunteers that work around water must be provided basic water safety training to include the following:

#### (a) The “Reach, Throw, Row, Don’t Go” method.

(a-1) Reach. Hold on to the dock or your boat and reach your hand, a boat oar, a fishing pole, or whatever you have nearby, to the person.

(a-2) Throw. If you cannot reach far enough, toss things that float for the person to grab.

(a-3) Row. If you are in a boat, use the oars to move the boat closer to the person in the water, or call out to a nearby boat for help. Do not operate the boat’s motor close to a person in the water, they could be injured by the propeller.

(a-4) Don’t Go. Do not go into the water unless you are trained. Call for help.

(b) Hazards associated with working around water (for example, temperature, depth, current)

(c) Hands-on training on how to use rescue equipment (for example, throw rings and bags) and personal protective equipment (PPE) (for example, personal flotation devices (PFD)) properly.

Information put together by the National Water Safety Program that can be used during water safety training is in the NRM Gateway Water Safety Section under Training and Conferences.

<https://corpslakes.erdc.dren.mil/employees/watersafety/water.cfm>

The version that is on the NRM Gateway is a PDF with notes. If anyone would like the PowerPoint version contact Pam Doty, National Water Safety Program Manager (Pamela.J.Doty@usace.army.mil) to request it.

The FY98-23 USACE Public Recreation Fatalities Data Summary is on the NRM Gateway in the water safety section under Water Safety Program Statistics.

<https://corpslakes.ercd.dren.mil/employees/watersafety/water.cfm>

Fatalities summary infographic, one page summary sheets for USACE and every division, division fatality totals spreadsheet, line graph of USACE water-related fatalities since 1971, and USACE Public Recreation Fatalities Dashboard are also provided on the NRM Gateway.

Our target audience is adult males (18 and older) not wearing life jackets because our statistics from FY98-23 show that 88% of our public recreation fatalities were male, 82% were 18 and older, and 89% were not wearing a life jacket. Ten year statistics (FY14-23) show that 88% of our public recreation fatalities were male, 86% were 18 and older, and 89% were not wearing a life jacket, so please focus on promoting water safety to adult males and increasing life jacket wear.

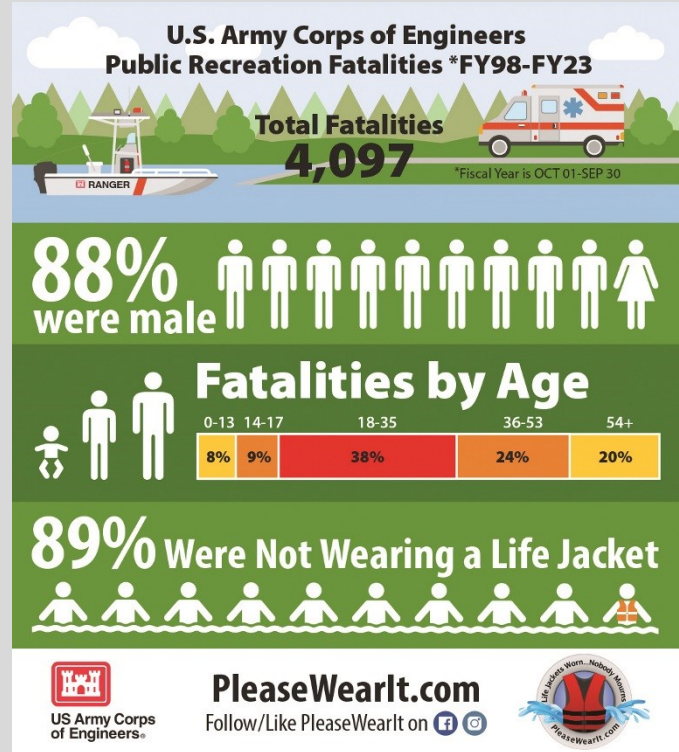
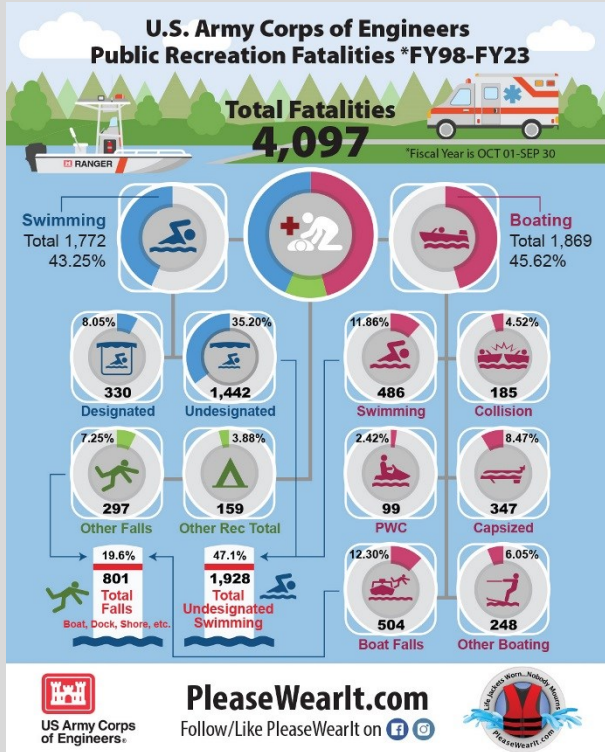

**2024 Life Jacket Video Contest**  
CONTEST DEADLINE: AUGUST 18, 2024

**THE PRIZE:**  
\$5,500 for 55-second Video PSA  
\$2,500 for 25-second Video PSA  
\*ONE WINNER PER CATEGORY WILL BE SELECTED

TO LEARN MORE:  
[www.LifeJacketVideoContest.com](http://www.LifeJacketVideoContest.com)

Life Jacket Worn... Nobody Hurt  
PleaseWearIt.com

This video contest is being done in cooperation with the Corps of Engineers Natural Resources and Education Foundation (The Corps Foundation) utilizing U.S. Coast Guard grant funds.

Contest ends August 18, 2024

Contest website <https://www.LifeJacketVideoContest.com>

Your help is needed to promote this contest to partners, colleges, universities, and visitors. A flyer, draft news release, and social media image are on the contest website under Resources and Promotional Items that you can use to promote the contest. Your help in doing this will be very much appreciated.

Videos from previous video contests that have been made into public service announcement can be seen on the National Water Safety Program's YouTube channel [www.youtube.com/user/USACEwatersafety](http://www.youtube.com/user/USACEwatersafety) and downloaded on the National Water Safety Program's webpage, [https://www.usace.army.mil/Missions/Civil-Works/Recreation/National-Water-Safety\\_Program/](https://www.usace.army.mil/Missions/Civil-Works/Recreation/National-Water-Safety_Program/), which PleaseWearIt.com redirects to.

## Resources to Help You Promote Water Safety

### USACE National Water Safety Program's Webpage

[www.usace.army.mil/Missions/Civil-Works/Recreation/National-Water-Safety\\_Program/](http://www.usace.army.mil/Missions/Civil-Works/Recreation/National-Water-Safety_Program/)

(PleaseWearIt.com redirects to this) Includes Life Jackets Worn...Nobody Mourns Campaign Materials, Water Safety Tips in English and Spanish, News Releases, and more.

**Please Wear It Social Media Pages** on Facebook, Instagram, and Twitter. These are the National Water Safety Program's social media pages that are managed in cooperation with The Corps Foundation.

### NRM Gateway Water Safety Section

<https://corpslakes.erdc.dren.mil/employees/watersafety/water.cfm>

Includes USACE Strategic Campaign Plan for Reducing Public Recreation Fatalities, Public Recreation Fatalities Data Summary and Statistics, Life Jacket Loaner Program Guidelines, Promotional Materials Policy, GSA Vehicle Public Safety Marking Guidance Memo, Life Jacket Mandatory Wear Policy Selective Expansion Memo, Water Safety Graphics Library, Media Interview Fact Sheet, Water Safety Resource Guide for Interpretive Services and Educational Outreach, Bobber the Water Safety Dog Costume Guidelines, and much more.

**Bobber the Water Safety Dog website** [www.Bobber.info](http://www.Bobber.info)

### National Water Safety Program's YouTube Channel and DVIDS Unit

[www.YouTube.com/user/USACEwatersafety](http://www.YouTube.com/user/USACEwatersafety)

[www.dvidshub.net/unit/USACE-WS](http://www.dvidshub.net/unit/USACE-WS)

Numerous water safety video PSAs are available and can be downloaded on the DVIDS Unit page so you can use them however you can to promote water safety.

Past issues of this quarterly water safety journal "Ripples" are on the NRM Gateway

<https://corpslakes.erdc.dren.mil/nrm.dfm>

A new Bobber the Water Safety Dog poster and coloring sheet for St. Patrick's Day is available on Bobber's website, [www.Bobber.info](http://www.Bobber.info). They are only available for a limited time so hurry and download them today! Please use them to promote water safety during your events and interpretive programs and share with your partners, visitors, libraries, schools, etc.





## Resources from One of Our Partners

### Waves of Hope

Is a group of family members and individuals that work together to prevent boating and open water tragedies because their lives were forever-changed when they lost a family member in a water-related incident or experienced a water-related incident personally. They share their stories so that you can use them to educate others about water safety.

Read and Share Their Stories: [www.safeboatingcouncil.org/wavesofhope/our-stories/](http://www.safeboatingcouncil.org/wavesofhope/our-stories/)

Waves of Hope family members that were lost in a boating or water-related incident are honored on the Please Wear It Facebook and Instagram pages that are managed by the National Water Safety Program in cooperation with The Corps Foundation. Visit [www.facebook.com/PleaseWearIt](http://www.facebook.com/PleaseWearIt) and [www.Instagram.com/PleaseWearIt](http://www.Instagram.com/PleaseWearIt) and share the posts on your social media pages.

#### Brian & Nathan Keese

Brian 1973 - 2010  
Nathan 2002 - 2010

On March 27, 2010, Brian and his son, Nathan, headed out for a fun day of fishing. Complying with Missouri law, life jackets were onboard but not worn because that state only requires children under seven to wear them. The boat capsized tossing both father and son into cold water. Neither survived.



#### Message from the Keese Family

"Never go boating without wearing a life jacket."



US Army Corps  
of Engineers



#### Connor Gage

1997-2012

On August 31, 2012, Connor went to a friend's birthday party at a lake house and didn't come home. Connor was a lake kid and an excellent swimmer. He and his friends got permission to swim. Connor jumped from a boat dock, landed badly, and didn't resurface.



#### Message from the Gage Family

"Good swimmers can drown and do. If you're in charge, make life jackets a must for everyone to wear."



US Army Corps  
of Engineers



#### Ryan Swain

1996-2013

On September 7, 2013, Ryan and three friends were duck hunting from the bank of a lake.

Ryan waded out to retrieve a duck and for unknown reasons, went under in only six feet of water.



#### Message from the Swain Family

"Regardless of age or physical abilities, no one is immune to the dangers of water."



US Army Corps  
of Engineers



#### Andy Free

2011-2020

On June 6, 2020, Andy and his family enjoyed the day boating and after a day at the rear of the boat Andy fell unconscious into the lake and never woke up again. It was later revealed that Andy died of carbon monoxide poisoning. Tragically, Andy's life was cut short by carbon monoxide, which is a colorless, odorless, and tasteless toxic gas.



#### Message from the Free Family

"Know the dangers of carbon monoxide while boating and think of Andy when you boat."

[Facebook.com/thelittleduderranch](https://www.facebook.com/thelittleduderranch)



US Army Corps  
of Engineers



AMERICA'S LAKES AND WATERWAYS



Waves of Hope resources for first responders including USACE employees:

THE 20/10/30 LIST was put together for first responders by the Waves of Hope families. It includes 20 things they wish you knew [and why], 10 things they'll never forget, and 30 helpful things to say and do.

[www.safeboatingcouncil.org/wp-content/uploads/2021/11/waves-of-hope-20-10-30-list.pdf](http://www.safeboatingcouncil.org/wp-content/uploads/2021/11/waves-of-hope-20-10-30-list.pdf)

**Dates to keep in mind:**

Sea Tow Foundation Online Life Jacket Loaner Conference

March 5 - 7, 2024

Conference website: [www.boatingsafety.com/page/lifejacketloanerconference](http://www.boatingsafety.com/page/lifejacketloanerconference)

Registration cost is only \$30 until March 1st and after that it increases to \$40.

International Boating and Water Safety Summit

April 8-11, 2024 in Albuquerque, NM

Conference website: [www.ibwss.org](http://www.ibwss.org)

USACE employees can use code: EXTENSION until April 8th to get the conference registration rate at \$250.

Wear Your Life Jacket at Work Day: May 17, 2024

National Safe Boating Week: May 18-24, 2024

Resources from the National Safe Boating Council for Wear Your Life Jacket at Work Day and National Safe Boating Week are available at <https://safeboatingcampaign.com/resources/>.

Operation Dry Water

Heightened awareness and enforcement weekend: July 4 - 6, 2024

Website: [www.nasbla.org/operationdrywater/home](http://www.nasbla.org/operationdrywater/home)

USACE lakes and river projects are encouraged to register as an outreach partner at [www.nasbla.org/operationdrywater/outreach/outreach-partners](http://www.nasbla.org/operationdrywater/outreach/outreach-partners)

Operation Dry Water is a national boating under the influence heightened awareness and enforcement campaign coordinated by the National Association of State Boating Law Administrators (NASBLA) with the goal of removing impaired operators from the water and raising awareness of the dangers of boating under the influence.



There is an image hidden in this journal. Your job is to find it. This journal's image is this one of Sinker. The actual image may be larger or smaller than what you see here. If you find the image, email Pam Doty, National Water Safety Program Manager, [pamela.j.doty@usace.army.mil](mailto:pamela.j.doty@usace.army.mil). Your email MUST include the subject as Ripples Journal Image, your name, shipping address, phone number, and the journal page number where you found the image. Entries need to be sent NLT March 6, 2024. The first five USACE employees that submit their entry correctly will receive Life Jackets Worn...Nobody Mourns dry bag that was donated to the USACE National Water Safety Program by The Corps Foundation.



[www.Bobber.info](http://www.Bobber.info)